

FOODTECH

Food Processing Systems



聯新 包裝機械
食品機械

2018年再投資設立全新客戶服務中心



*本公司為永保 **專業、創新**
2018年度設立全新展示試機中心，
可和國外原廠同步展示最新加工及包裝設備。

*業界最先進齊全之員工訓練中心，
不斷提升**售前及售後**服務之品質。

*先進舒適之客戶服務中心，陪客戶一同分析
及找出最佳解決方案。

*目前領先業界之零件庫存整備中心，
空間再擴大一倍之規模。

*下一階段目標為全面提升台北分公司
之軟硬體設備。

我們以上之投資只為了永保
專業、創新，永續經營之承諾，
並為了邁向下一個30年預作準備。



維修工程師定期國外原廠受訓，不斷提升維修技術



同步引進國外先進加工設備與加工技術分享國人





全台銷售量突破100台，知名大廠使用好評中

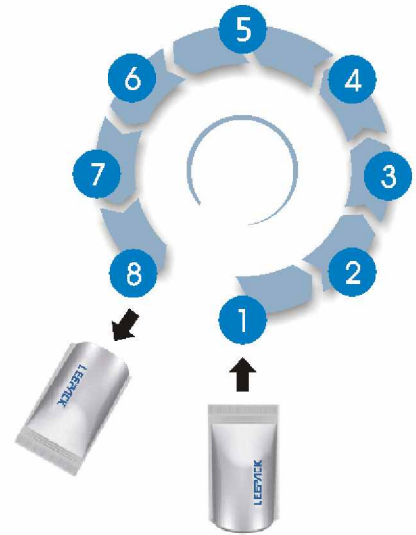

適用於：

調理食品如羊肉爐、魚丸、魚翅、藥膳料理包、蜜餞、糖果、毛豆、豆干、米、醬菜、休閒零食、果醬、高湯汁、殺菌軟袋

主要用途：

1. 液體/飲料、沐浴乳、清潔劑。
2. 顆粒/化學調味料、魚飼料、肥料、砂糖、食鹽。
3. 散物/穀類、豆類、豆果子、食品、豆干類。
4. 粉末/各種粉類、調味料。
5. 固型物/米果子、半生果子、糖果、餅乾。
6. 部品/電器零件、五金、塑膠製品、橡膠製品。

	液體	醬料	醬料含固物型	乾料	顆粒狀	粉料	其他
平口袋							
夾鍊袋							
站立袋							
站立夾鍊袋							
站立瓶口袋							
造型袋							
站立造型袋							
管狀PE袋							



全機可水洗裝置



開夾鏈袋裝置



創新抽氣裝置
可達90%真空



雙包式一起來
二包產能加倍

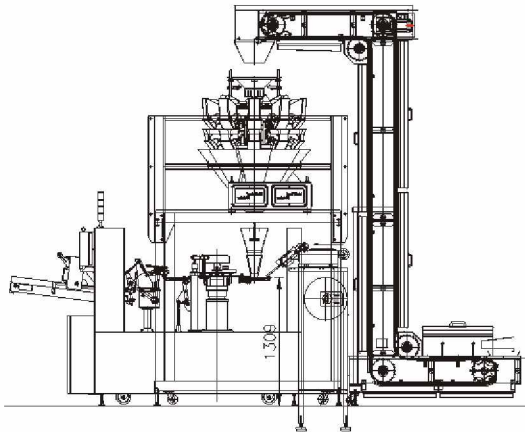

• 搭配多頭秤包乾料

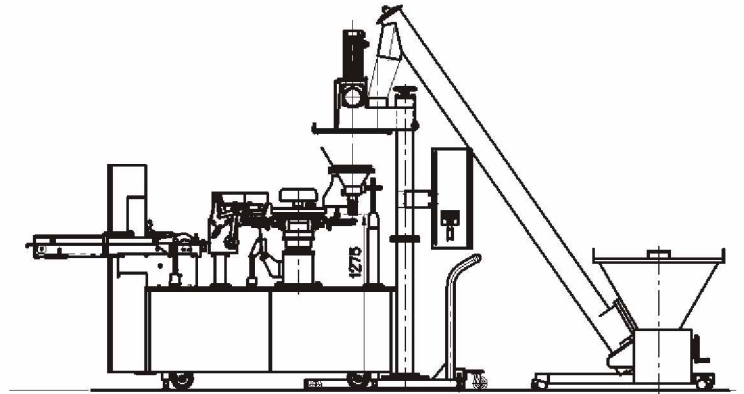

• 搭配粉體定量機

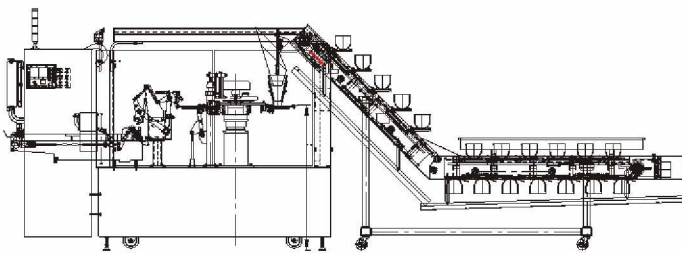

• 搭配碗型輸送帶，投入固型物再搭配液體充填機



ROBOT FOOD TECH

LEADERSHIP IN PACKAGING

自動定量設備(飯、麵、肉、菜)



• 固形物自動定量機



• 獨特輸送設計、長條狀、顆粒，不規則的產品皆可定量，免人力定量

托盤真空、充氣、貼體包裝機 義大利—貼體科技之發源地



SKIN TECHNOLOGY



封合、真空充氣、貼體三機一體全能機



水平式製袋充填封合機



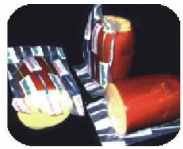

硬盒抽氣、封合、貼體，
皆可使用之全能機。

真空、充氣、貼體 三機一體



● 重量分級機



● 每片不同重量原料，秤重後自動配對成
每堆固定重量，省人力，提高精準度。



肉品切割設備之世界第一品牌



● 砍排切片切絲機



● 計片分堆疊片，省人力



● 多種爪鉤可選配



● 連續式掃描定重切片



● 歐式麵包切片機



冷凍肉擠壓成型機

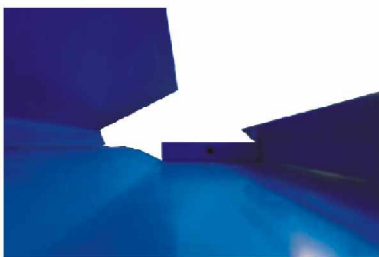

● 3D擠壓衛生級模具



3D擠壓技術
可產生50頓
的力道

降低對
肌肉的
損傷

衛生級設計

● 搭配後續切片機，可大幅提升製成率及達到大約定重之效果。



整箱冷凍肉直接切絲、丁、片 之實踐者



● 小型切丁、切絲機

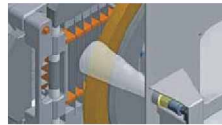

● 超音波定厚

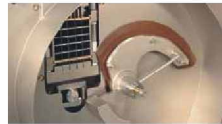

● 智慧變速系統



● 中型切丁機



● 全自動大型切丁機
(整箱冷凍肉及冷藏肉雙用型)



● 整箱冷凍肉

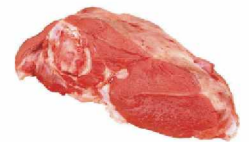

● 冷藏肉



軌跡式圓刀
適合較硬之產品
需較多之保養



鐘刀式刀片
快速、精準，
保養簡單容易
和產品磨擦最少



● 火腿、培根、切片、疊片機

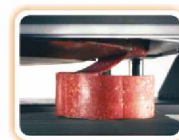

專利SAS堆疊系統，
可直立堆疊達100m/m



(堆疊效果世界第一)



送料幫浦

充填機吐出能力及定量精準之關鍵



- **F-40**
每格 82 公克
每圈吐出量 82gx8=626g
直徑180mm



- **F-100~200**
每格 82 公克
每圈吐出量 82gx14=1148g
直徑235mm



- **F-222**
每格 76 公克
每圈吐出量 76gx16=1216g
直徑270mm



世界專利免皮帶驅動打結手臂

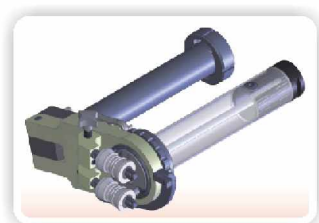

- 專利打結手臂，簡單好操作，保養少，衛生程度高

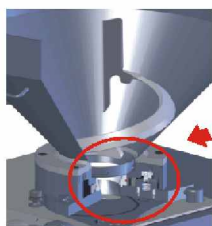

堅固強壯設計

- 料斗內撥料傳動堅固耐用之設計

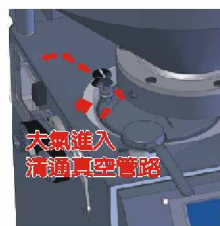

大氣進入
清通真空管路

- 專利免停機，自動清通真空管路，避免真空阻塞



- 堅固耐用之Peek CAM幫浦

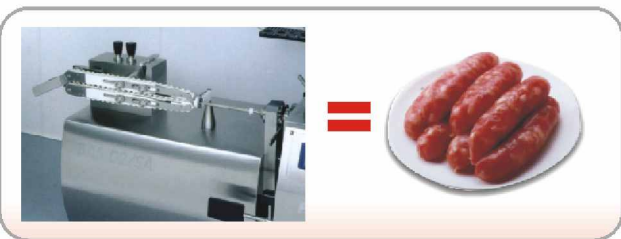

- 配合天然腸衣整型定長輸送帶



2018最新機種 熱狗香腸高速打結定長系統

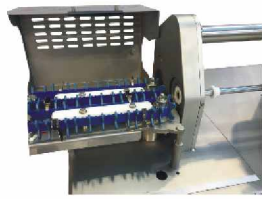

● 活動式鏈條

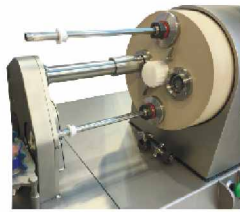

● 快速換腸衣

- 速度快
- 長度精準
- 產品不餽化



專屬CL配件



● 定量切斷機



● 分流切斷成型



● 仿手工漢堡肉排



丸子及火鍋料

● 最新型線性馬達搓圓科技

充填機搭配包裝機 全自動生產 大省人力



(A) 搭配給袋式包裝機 (各式袋子)
自動取袋→開袋→充填→封口

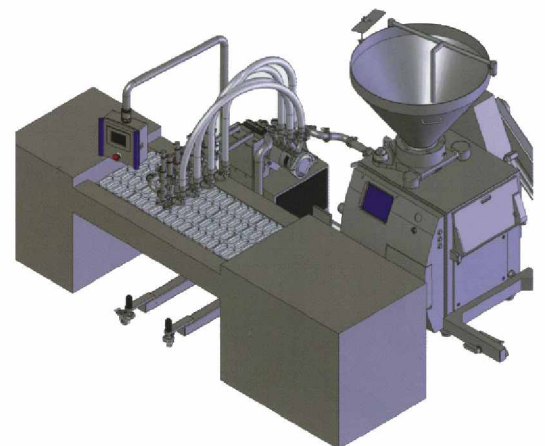
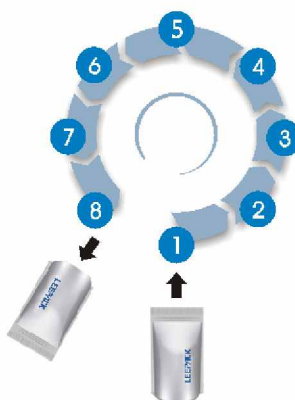

(C) 搭自動成型製袋包裝機



(B) 搭直立式製袋包裝機 (豆沙)



● 熱狗剝皮機



● 熱狗打結機



● 手動打釘機



● 橫式全不銹鋼打釘機



● 附拉力打釘機



● 落地型
雙釘式打釘機



● 各式鋁釘



● 氣動式
全不銹鋼打釘機



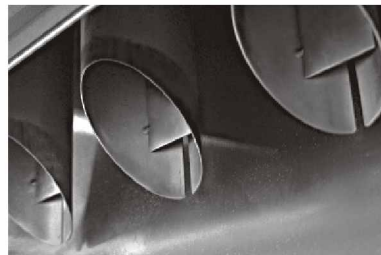

● 氣流循環設計



● 專利提升式門栓，經久耐用

發煙技術

專利煙燻科技，燻燻技術全世界之領導者

煙燻速度快、均勻、大省木屑及能源

世界專利RATIO-TOP發煙系統

- 集合200°C-450°C 各種不同香味及顏色之煙，此系統兼具健康、環保、煙燻效率之最先進發煙系統。

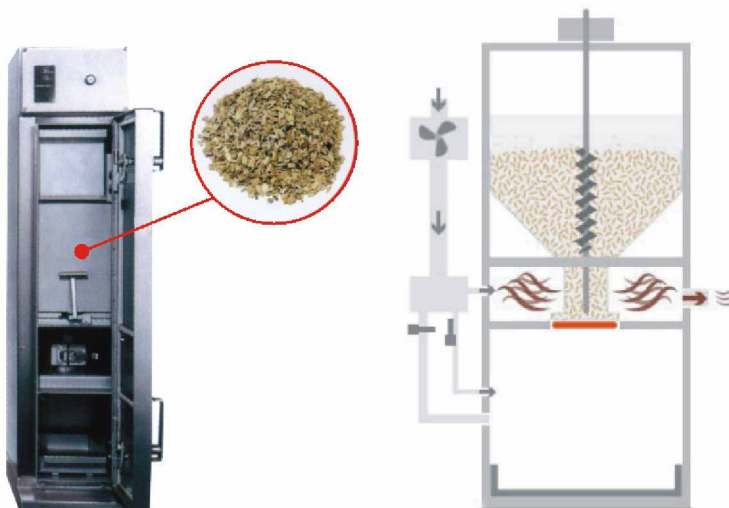

煙燻成份分析

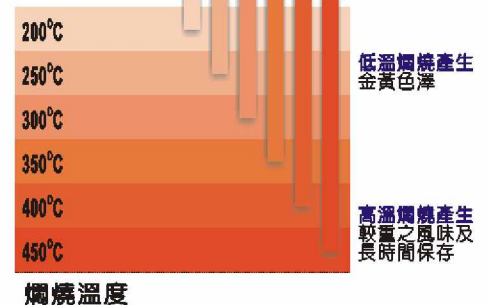



- 原理：利用27.12Mhz高週波使產品內部水分子振動，由內而外加熱進而解凍產品。
-18°C解凍至-2°C，僅需數十分鐘，且不產生血水。

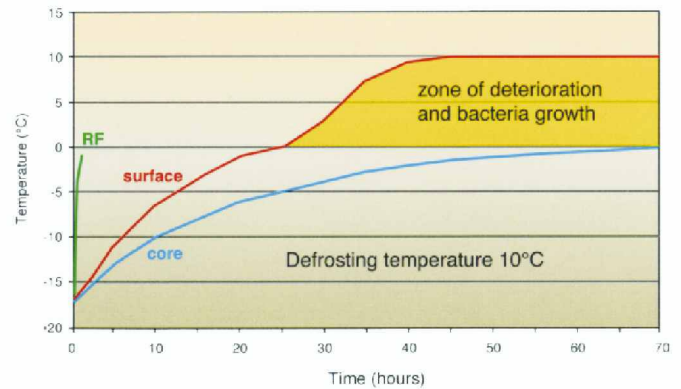
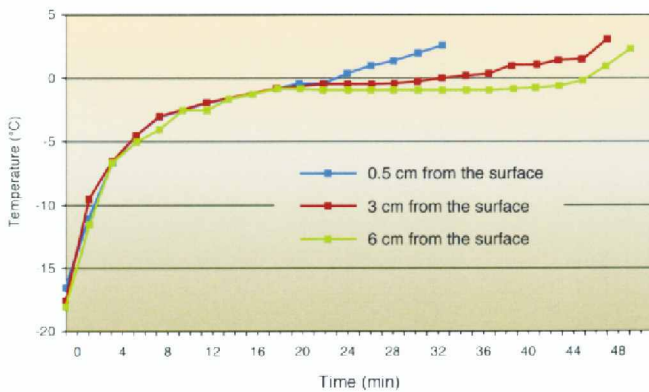
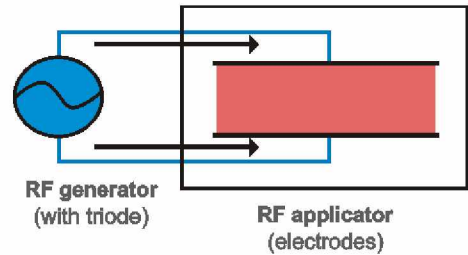
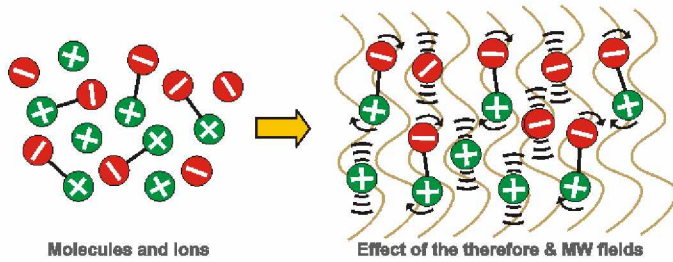

- 使用高週波解凍設備，產品表層、中層及深層溫度，同時穩定上升解凍十分均勻。

- 對比傳統解凍，高週波解凍可以省下數十小時解凍時間，且不會血水及細菌產生。

適用



- 整箱冷凍牛肉
25%脂肪



- 冷凍雞胸肉



- 牛肉



- 冷凍帶骨雞腿排



- 整箱冷凍豬肉
肩胛肉



- 冷凍魚鯉塊



- 整箱冷凍豬肉
30%脂肪



- 冷凍鮭魚



● 85kw機型

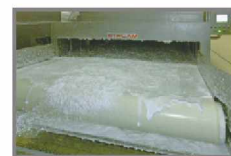



● 小型、中型變頻驅動

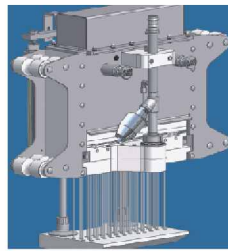

- 創新單管式管路，易清洗。
- 可更換針座，變化為多種用途。



● 大型伺服驅動注射機



● 攪拌，按摩雙用



針碰到骨頭，汁液停止注射，確保骨頭周圍沒有多餘之汁液



● 滾刀式鬆肉機



● 半自動



● 全自動免人力



- 適合各種冷凍食品零下18°C直接削塊，產品容易解凍，可容易絞碎。
可適用於最大尺寸肉塊寬50cm X 高25cm X 長100cm

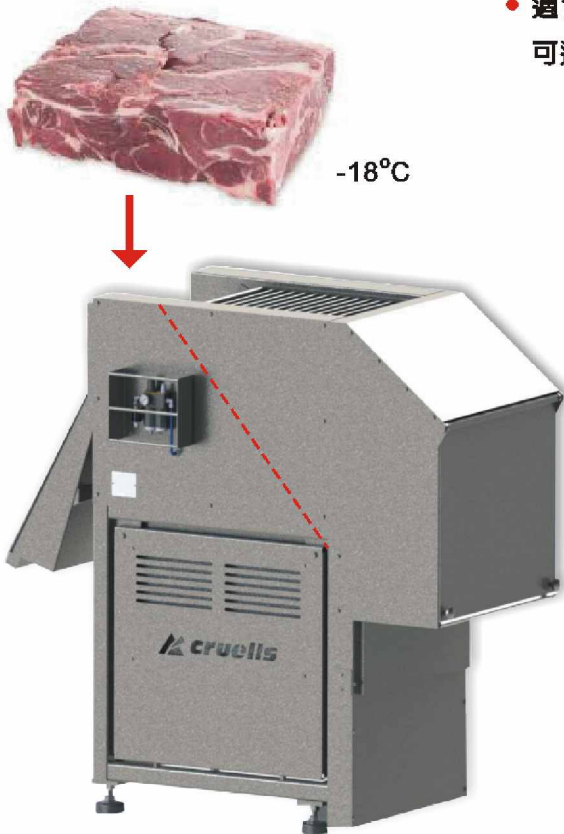

直接切成 4 x 6.3cm 之小肉塊



切丁機



絞肉機

- 中型機種可連續入料，有入料斜坡，切削時肉塊不會回彈。



- 桶子可傾倒，出料乾淨完全，易清洗。



T型或獨特Z字型攪拌臂混合搓揉效果最好

- 雙軸傾倒式混合機。
150-1300公升，機種齊全。



● 全不鏽鋼螺桿



● 專利雙段式螺桿

兩種螺桿可選擇



● 大小機種齊全



● 可選配攪拌臂

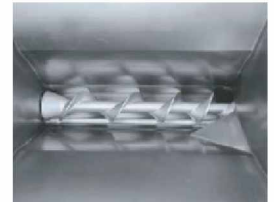

● 輔助入料斜坡



● 頂級鋸骨機



● 整箱冷凍肉直接絞碎機



● 軟骨、筋膜分離裝置



● 水浸式磨刀機



● 實驗室細切機
13,20ℓ



● 超值細切乳化機
35~135ℓ

專利旋轉刀及密縫刀架之剪切式均質乳化系統



- 特點：

每分鐘**1,500,000**次之切割，可以達到超微細**0.05mm**之乳化均質效果，增加產品之質與量，降低成本，是您致勝之祕密武器。

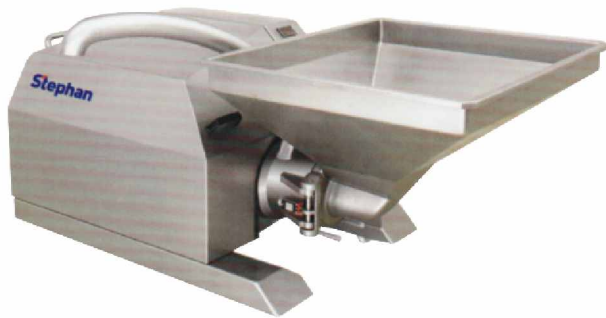

• 臥立乳化均質機

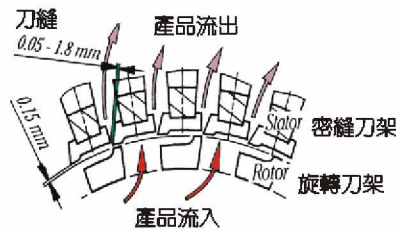

• 剪切均質刀具

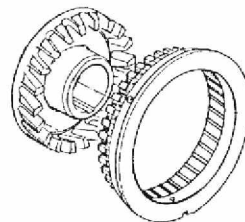

• 直立乳化均質機

可細切乳化真空、加熱、降溫，可攪拌、混合、可磨碎



機種45-150公升

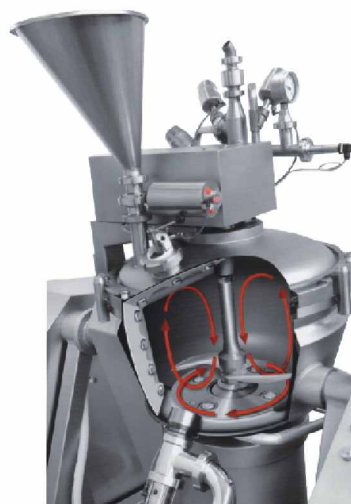

均勻循環之原理



機種5-12公升

- 適用於：
素食業、豆腐類、沙拉醬、魚漿 煉製品、果汁原料、各種汁液均質、乳類製品、肉類製品、生化科技、冰品、嬰兒食品、糖果、巧克力等之均質乳化

50年之歷史值得信賴



- 小型細切乳化機
60~125ℓ



- 大型細切乳化機
200,325ℓ



- 直立式乳化機23~60公升
多種機種，可傾倒出料，
並可加裝真空裝置



- 小型乳化機機種3~6公升
附上蓋刮板



- 10.20L公升
附上蓋刮板

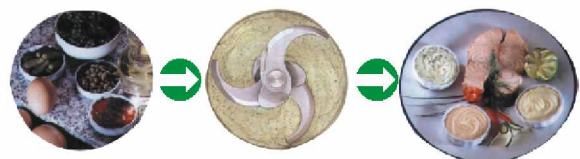

- 適用於食品工廠、餐廳、大飯店，
香料工廠之各種產品之細切乳化均質



魚類剥皮機之世界領導品牌



• 豬皮

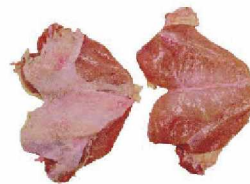

• 雞肉



• 雞腿



• 針對不同產品及不同的成品需求，POSS都能提供最佳的解決方案。



• 孔洞式濾網

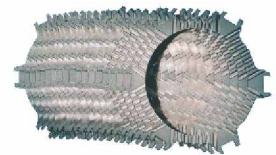

• 葉片洞式濾網



• ProMax500:投入成本低，回收快

廢料取肉 低成本 回收快

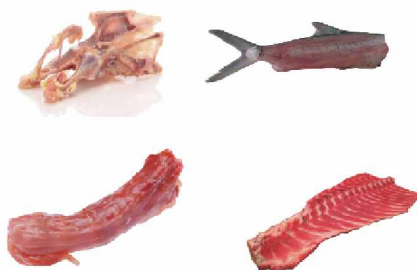

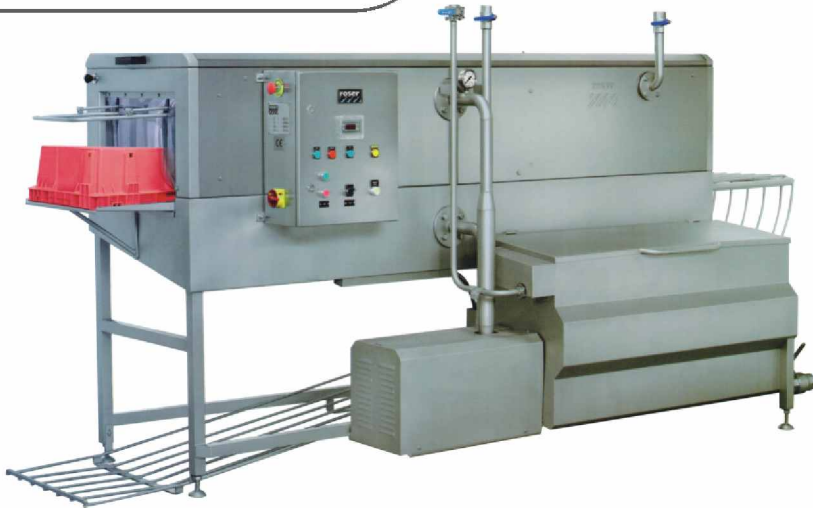

● 全自動洗籃機(多種尺寸可供選擇)



● 不銹鋼桶自動清洗機

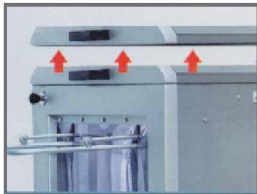

● 上蓋可取出，清洗無死角。



● 過濾裝置



● 堅固耐用之噴嘴

不銹鋼桶、升降入料設備、洗鞋機

- 世界最高級之不銹鋼桶適用於各行各業



實心外框，耐用堅固



符合人體工學

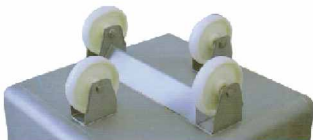

底部3mm厚板及V型強化裝置衛生佳



● 各種升降設備
自動化入料



● 全自動洗鞋機



● 洗鞋機大小機種齊全





● 油壓式充填機13~30公升



● 進口#22、32
全不銹鋼絞肉機



● 進口強力型
全不銹鋼絞肉機



● 手動注射機



● 磨刀機



● 真空型乳化
細切機5~12公升



● 手動充填機機種
6公升、9公升、12公升



● 肉類、魚漿、薯餅成型機

螺旋式燒烤機



● 進、出口方向多種選擇

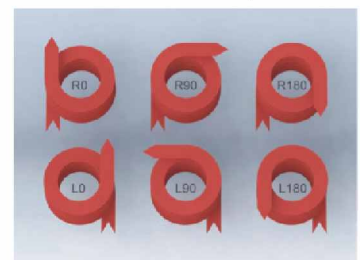

原廠耗材



• 刀片



• 乳化機刀片



• 網刀



• 絞刀



• 鋸條



• 各式鋁釘



• 鋼絲手套



• 吸盤



• 膠膜

專業磨刀服務

- 不惜巨資引進德國原廠磨刀設備。
- 使刀片研磨更精準，切割效果更佳，增加客戶之利潤。
- 增長刀片壽命，減少磨刀頻率。



TIPPER TIE
ALPINA



認證原廠同等級磨刀設備



www.utt.tw



聯新貿易有限公司

UNITE TOP TRADING CO., LTD

■ 台中總公司：台中市豐原區大勇街30號
 TEL:(04)2525-6486
 FAX:(04)2525-1843
 E-mail:sales@utt.tw

■ 台北分公司：台北市延平北路五段72號2樓
 TEL:(02)2811-8988 FAX:(02)2813-6150
 ■ 高雄分公司：高雄市左營區民族一路1070-2號
 TEL:(07)3107955 FAX:(07)3107953

www.utt.tw